

TAMPA MONTANTE GOLD NYL C/8PCS (NYL399)



CARACTERÍSTICAS

CODIFICAÇÃO		
COR	CÓDIGO	CATÁLOGO
BCO	9301272	TAMNYL399BCOE8
PRT	9301271	TAMNYL399PRTE8

OBSERVAÇÕES

COMPOSIÇÃO/CARACTERÍSTICAS:

- TAMPA: POLÍMERO.

APLICAÇÃO NOS PERFIS:

- GOLD: LG052 E LG054;

- CHROMA: CHR-050, CHR-051, CHR-089 E CHR-090.

APLICAÇÃO

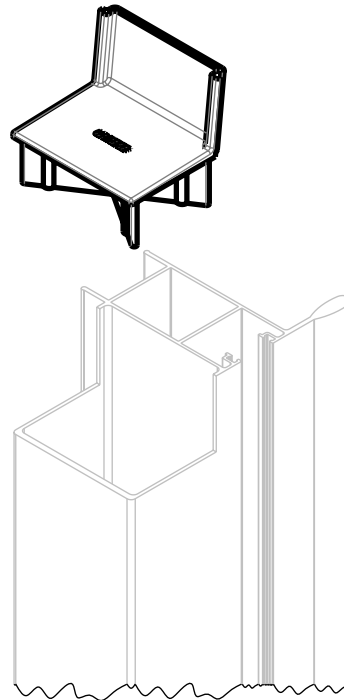

SEM ESCALA

USINAGEM

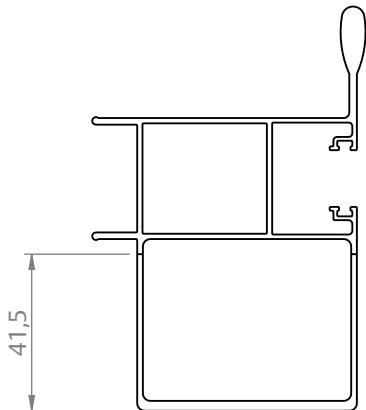
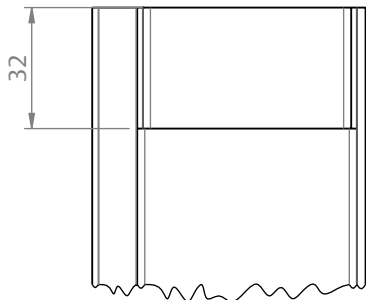

ESCALA 1 : 2

DIMENSÕES

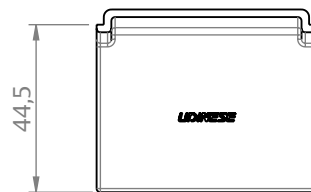
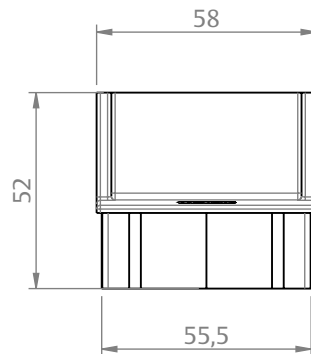

ESCALA 1 : 2

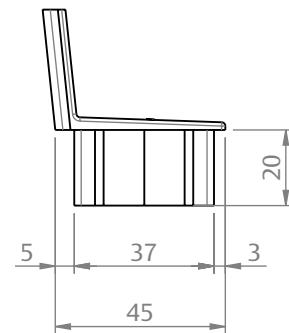

PORTA DE CORRER

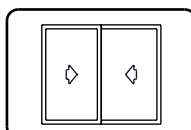

UDINESE
ASSA ABLOY