

ROLDANA DUPLA FIT REG/PH L25

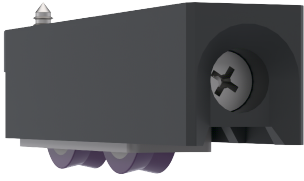

APLICAÇÃO

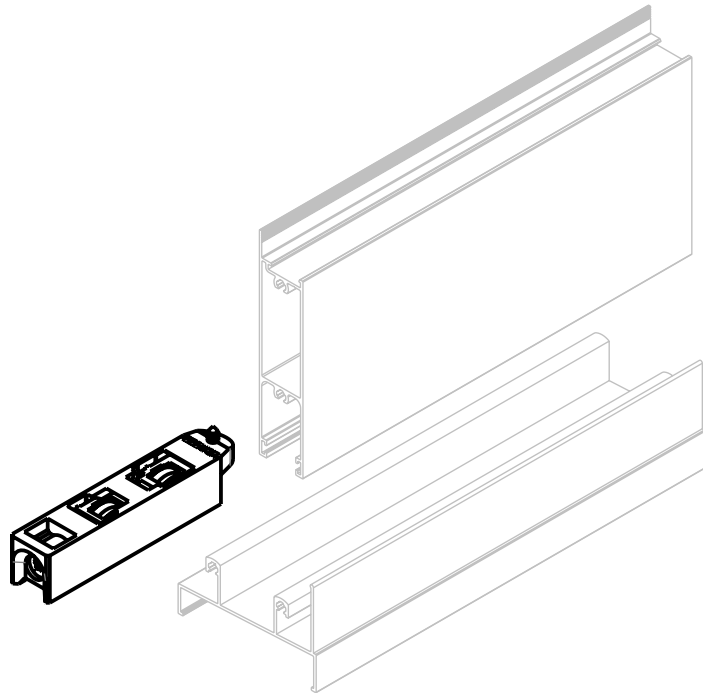

CARACTERÍSTICAS

CODIFICAÇÃO		
COR	CÓDIGO	CATÁLOGO
PRT	9001741	ROLDUPFITREGPHL251PC
CARGA MÁXIMA		
80 KG POR FOLHA		

OBSERVAÇÕES:

- UTILIZAR 02 ROLDANAS POR FOLHA.

COMPOSIÇÃO/CARACTERÍSTICAS:

- CAIXA DA ROLDANA E GARFO: POLÍMERO;

- RODÍZIO: AÇO/ POLÍMERO;

- PARAFUSOS: AÇO INOX.

DIMENSÕES

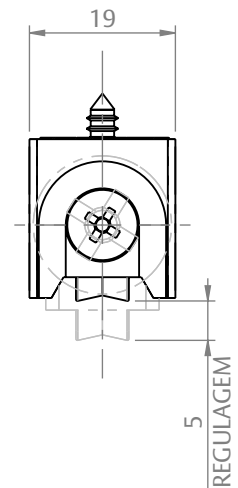
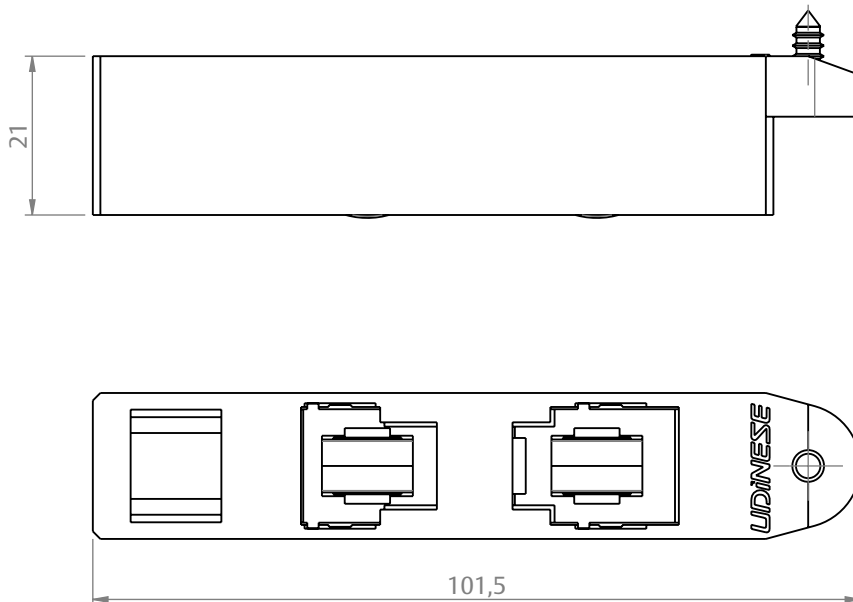

PORTA DE CORRER

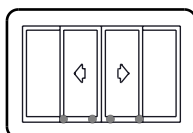

UDINESE
ASSA ABLOY

ROLDANA DUPLA FIT REG/PH L25

APLICAÇÕES

ECOLINE 2.5
(PERFIL ALUMÍNIO)

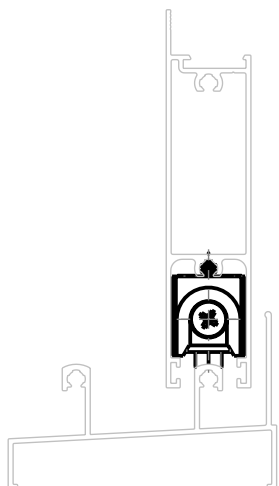

ESCALA 1 : 2

SUPREMA
(HYDRO)

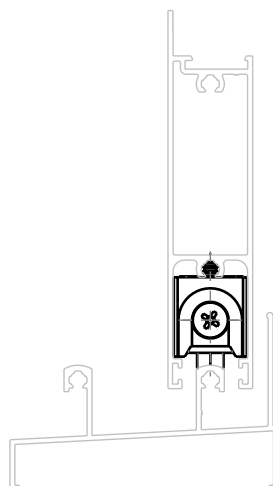

ESCALA 1 : 2

IMPERIAL 2.5
(BELMETAL)

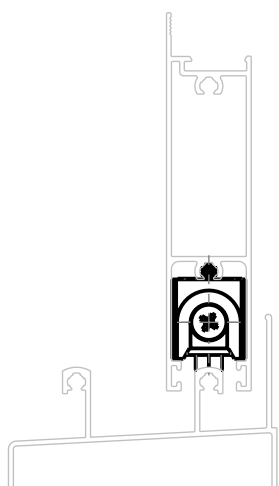

ESCALA 1 : 2

MEGA 25
(ASA ALUMÍNIO)

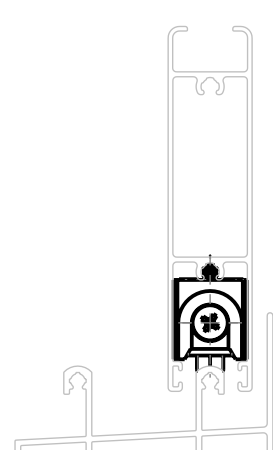

ESCALA 1 : 2

ROLDANA DUPLA FIT REG/PH L25

APLICAÇÕES

**AGLO 2.5
(OLGA COLOR)**

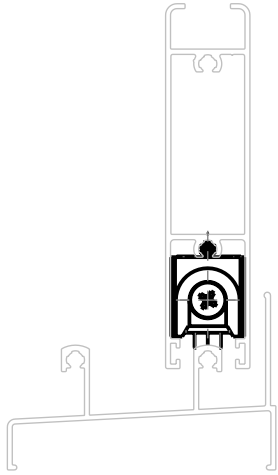

ESCALA 1 : 2

**ABSOLUTA
(CDA)**

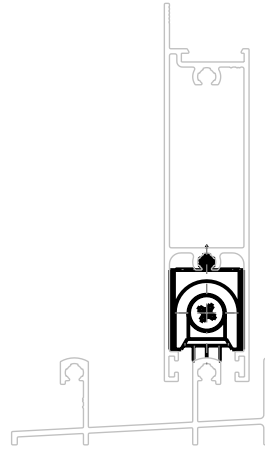

ESCALA 1 : 2

AUTEM 25 EX

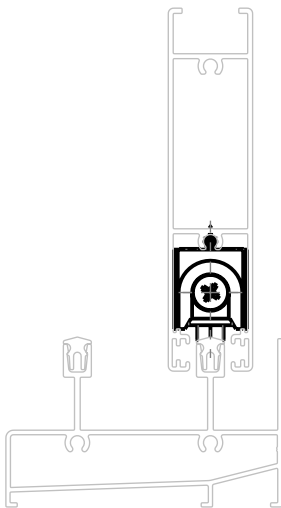

ESCALA 1 : 2