

# PUXADOR LINEA

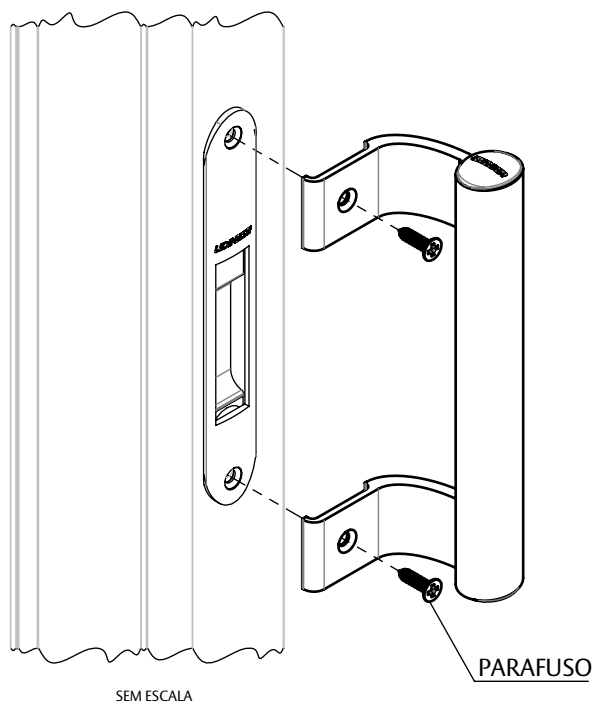

## APLICAÇÃO



## CARACTERÍSTICAS

CODIFICAÇÃO			
VERSÃO	COR	CÓDIGO	CATÁLOGO
166	BCO	9212003	PUXLINEA166BCO
	PRA	9212004	PUXLINEA166PRA
	PTF	9212005	PUXLINEA166PTF
198	BCO	9212006	PUXLINEA198BCO
	PRA	9212007	PUXLINEA198PRA
	PTF	9212008	PUXLINEA198PTF

### OBSERVAÇÕES

- FECHO CONCHA, CONTRA FECHO E LINGUETA SÃO VENDIDOS SEPARADAMENTE.

### COMPOSIÇÃO/CARACTERÍSTICAS:

- PUXADOR: ALUMÍNIO;
- TAMPAS: POLÍMERO;
- PARAFUSOS: AÇO INOX.

## DIMENSÕES

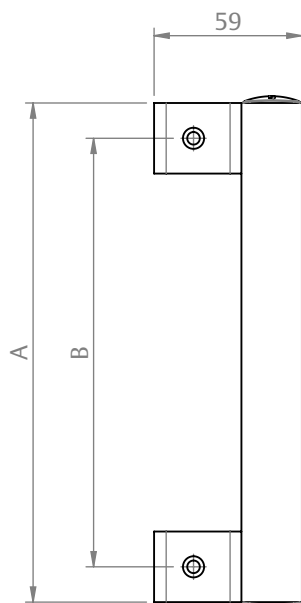
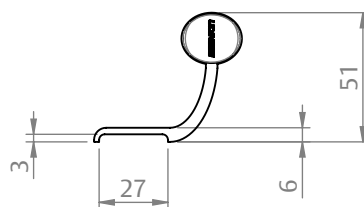
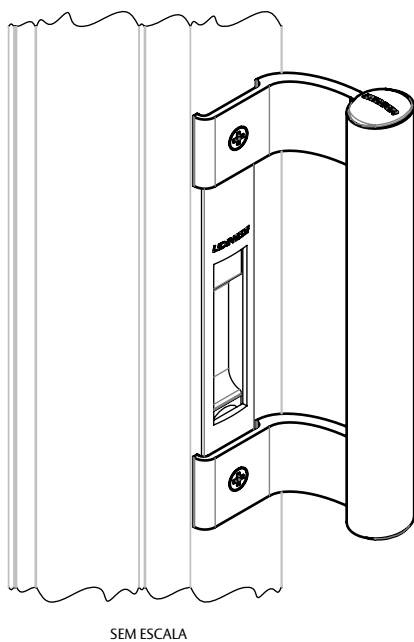

DIMENSÕES	
A	B
166	138
198	170

ESCALA 1:3

PORTA E JANELA  
DE CORRER

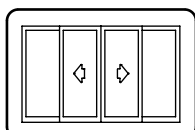

**UDINESE**  
**ASSA ABLOY**

# PUXADOR LINEA

## APLICAÇÕES

**MEGA 20  
(ASA ALUMÍNIO)**

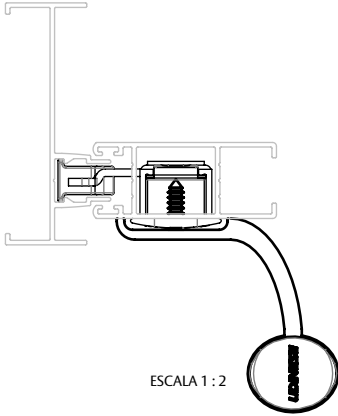

**MEGA 25  
(ASA ALUMÍNIO)**

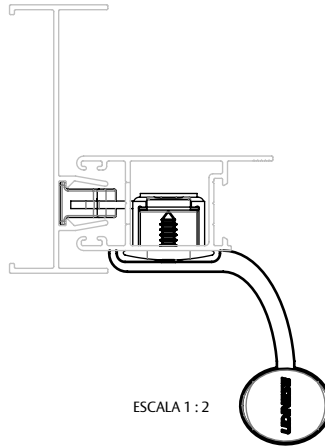

**MEGA 32  
(ASA ALUMÍNIO)**

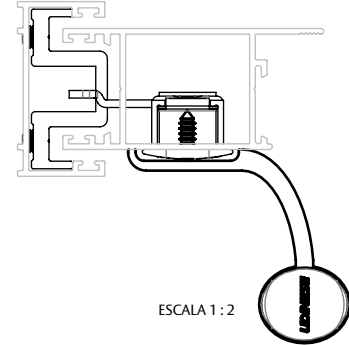

**IMPERIAL 2.5  
(BELMETAL)**

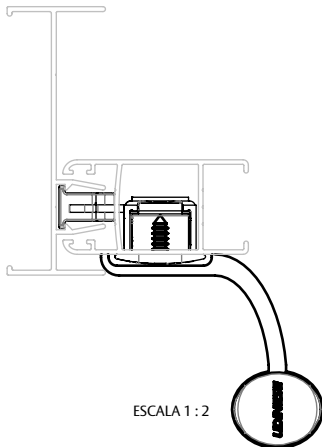

**IMPERIAL 3.5  
(BELMETAL)**

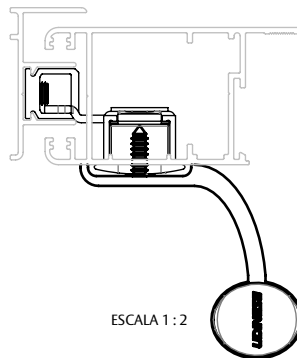

**SMART 2.0  
(BELMETAL)**

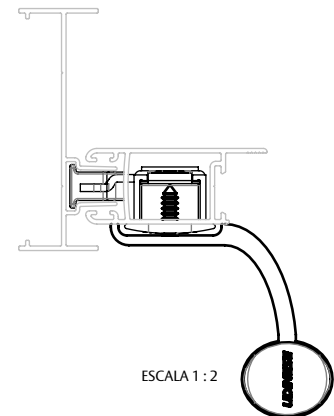

**ABSOLUTA  
(CDA)**

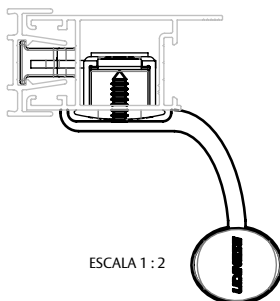

**RENOIR 2.2  
(CDA)**

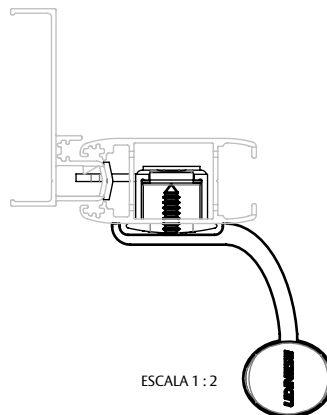

**RENOIR 3.3  
(CDA)**

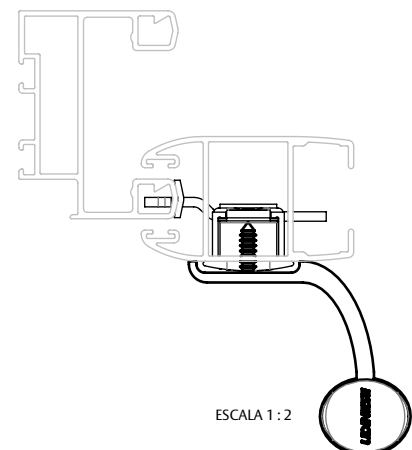

**UDINESE**  
**ASSA ABLOY**

# PUXADOR LINEA

**CONVENCIONAL 25**

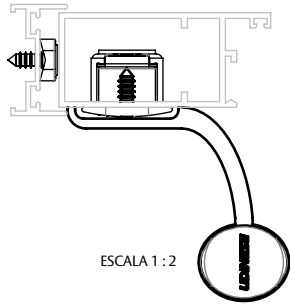

ESCALA 1:2

**CONVENCIONAL 30**

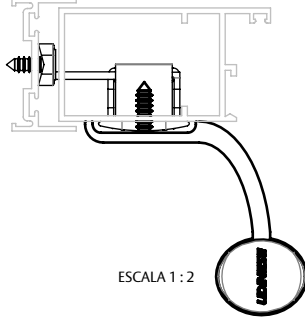

ESCALA 1:2

**CONVENCIONAL 42**

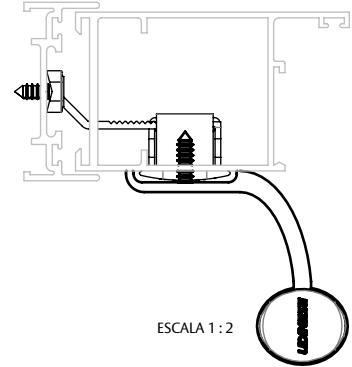

ESCALA 1:2

**ALUK 2.0  
(OLGA COLOR)**

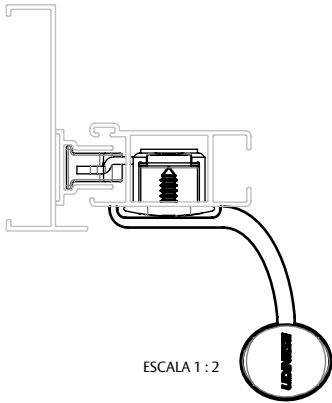

ESCALA 1:2

**ALUK 2.5  
(OLGA COLOR)**

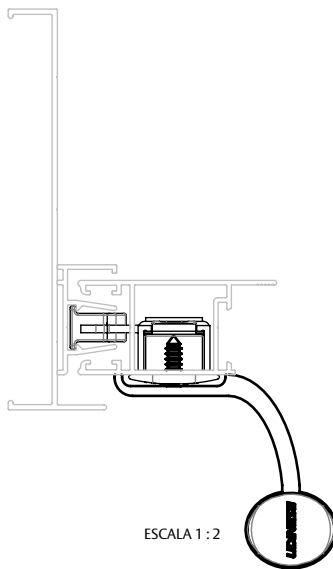

ESCALA 1:2

**ALUK 3.2  
(OLGA COLOR)**

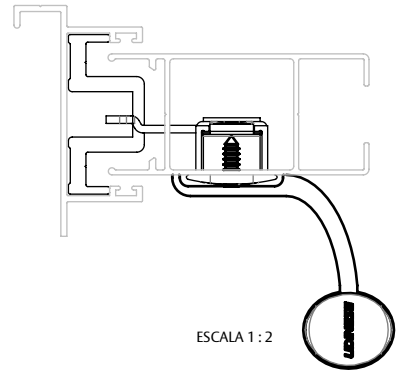

ESCALA 1:2

**GOLD  
(HYDRO)**

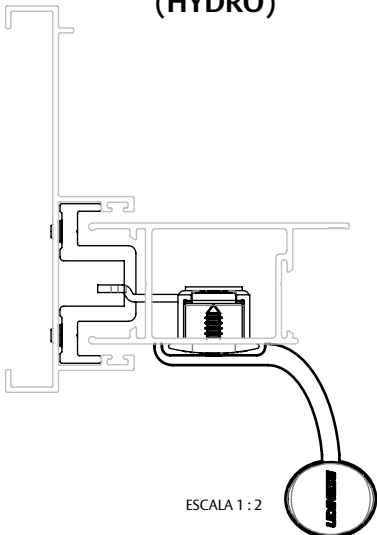

ESCALA 1:2

**SUPREMA  
(HYDRO)**

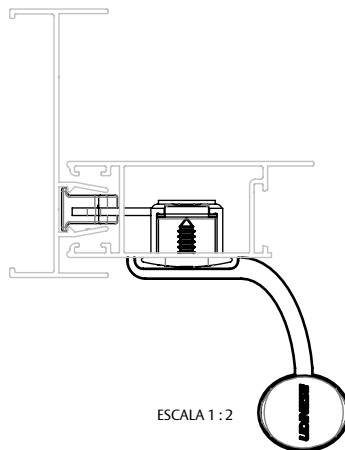

ESCALA 1:2

**UDINESE**  
**ASSA ABLOY**

# PUXADOR LINEA

**CHROMA  
(PERFIL)**

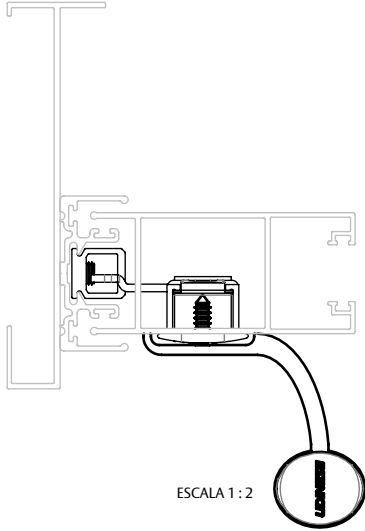

**ECOLINE 2.5  
(PERFIL)**

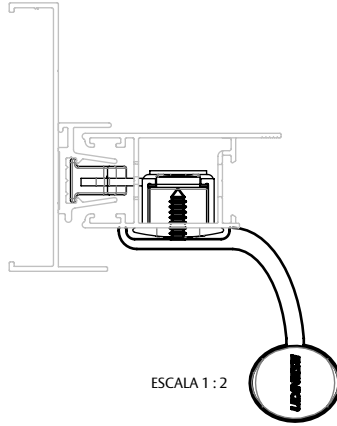

**SP20  
(SELTA)**

