

# CREMONA E25 EVO 2 PONTOS ACION. INTERNO

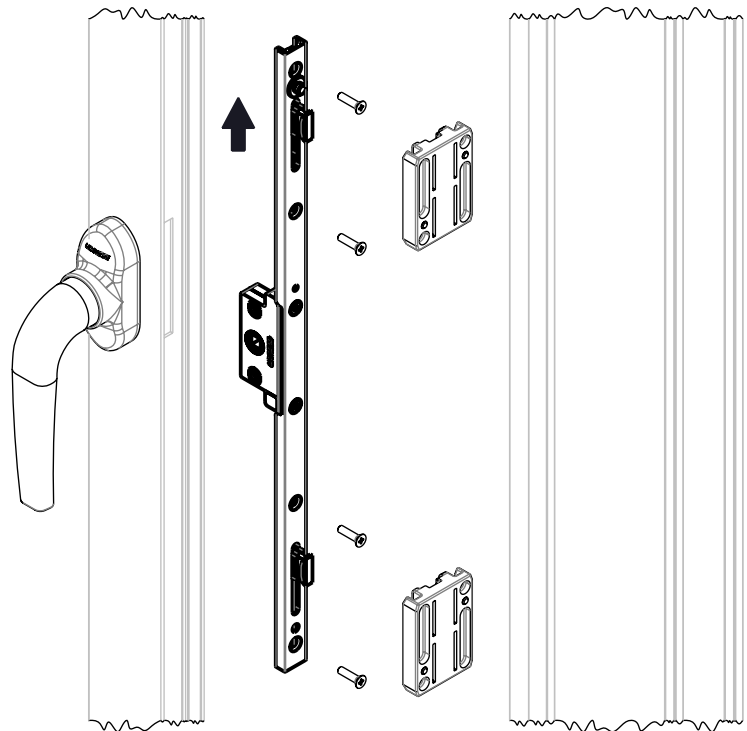

POSIÇÃO DE INSTALAÇÃO:  
BATEDOR NA PARTE SUPERIOR

APLICAÇÃO



ESCALA 1 : 4

## CARACTERÍSTICAS

### CODIFICAÇÃO

VERSÃO/ COTA "A"	COR	CÓDIGO	CATÁLOGO
400mm	BCO	9212290	CREE25EV2PIN400BCO
	PRA	9212291	CREE25EV2PIN400PRA
	PTF	9212292	CREE25EV2PIN400PTF
600mm	BCO	9212293	CREE25EV2PIN600BCO
	PRA	9212294	CREE25EV2PIN600PRA
	PTF	9212295	CREE25EV2PIN600PTF
800mm	BCO	9212089	CREE25EV2PIN800BCO
	PRA	9212090	CREE25EV2PIN800PRA
	PTF	9212091	CREE25EV2PIN800PTF
1300mm	BCO	9212092	CREE25EV2PIN1300BCO
	PRA	9212093	CREE25EV2PIN1300PRA
	PTF	9212094	CREE25EV2PIN1300PTF
1600mm	BCO	9212201	CREE25EV2PIN1600BCO
	PRA	9212202	CREE25EV2PIN1600PRA
	PTF	9212203	CREE25EV2PIN1600PTF

### OBSERVAÇÕES

#### COMPOSIÇÃO/CARACTERÍSTICAS:

- MAÇANETA, KIT HASTE E CONTRA FECHOS VENDIDOS SEPARADAMENTE;
- PARAFUSOS DE FIXAÇÃO NÃO FORNECIDOS PELA UDINESE.

#### APLICAÇÃO NOS PERFIS:

- VARETA: ALUMÍNIO;
- CAIXA CREMONA: ZAMAK;
- PARAFUSOS: AÇO INOX.

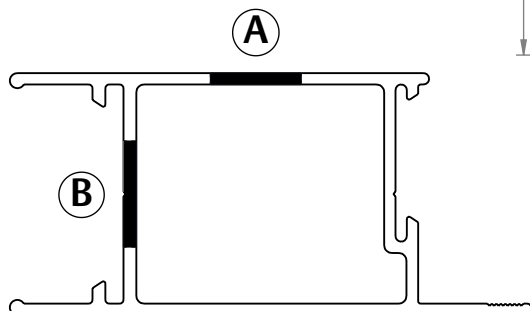

ESCALA 1 : 1

### USINAGENS

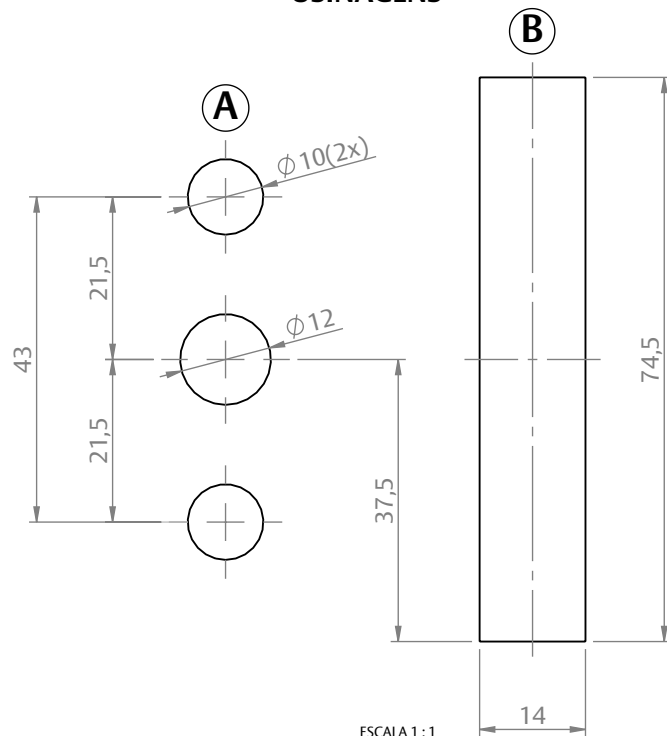

ESCALA 1 : 1

PORTA E JANELA  
DE CORRER

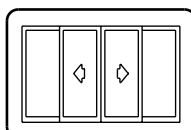

**UDINESE**  
**ASSA ABLOY**

# CREMONA E25 EVO 2 PONTOS ACION. INTERNO

## DIMENSÕES

VERSÕES 400mm, 800mm,  
1300mm E 1600mm

VERSÃO 600mm\*

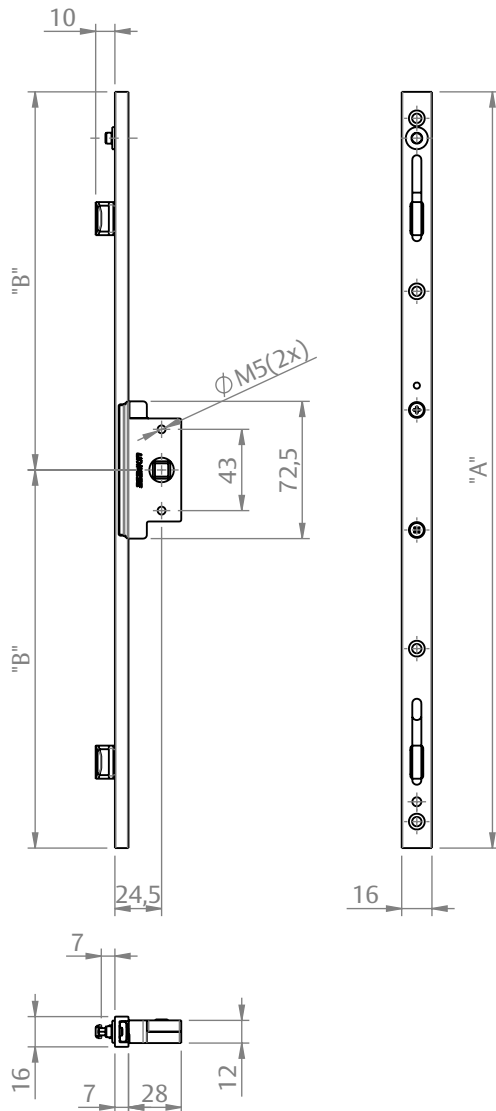

ESCALA 1 : 4

VERSÃO/ COTA "A"(mm)	B(mm)
400	200
800	400
1300	650
1600	800

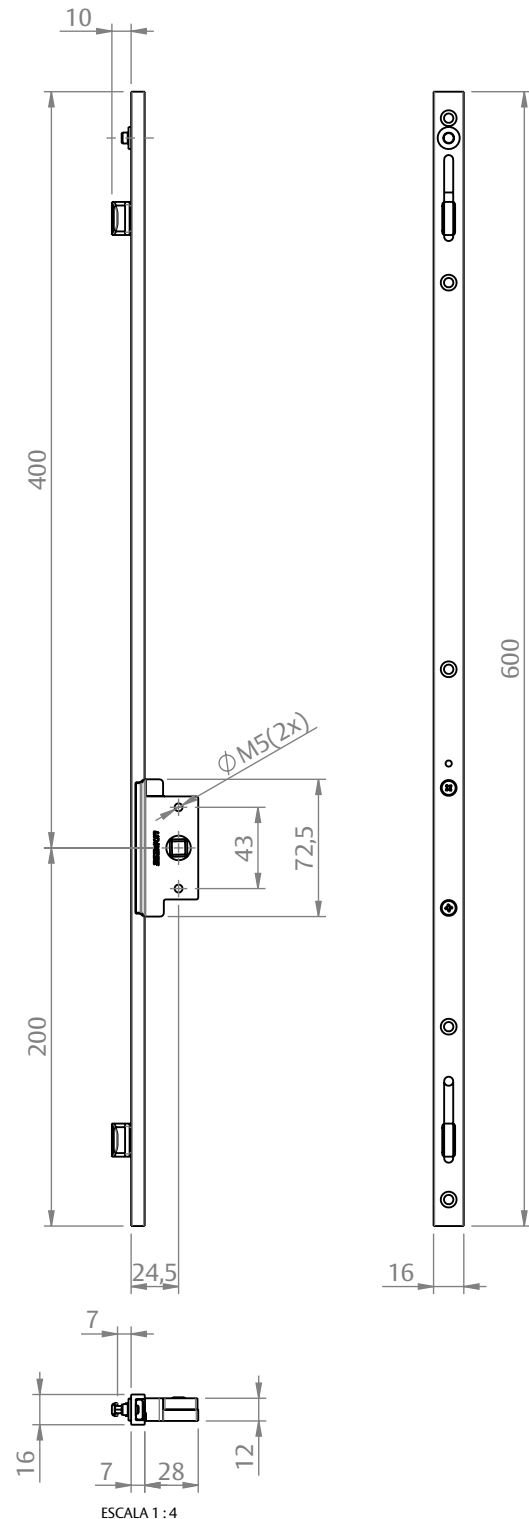

ESCALA 1 : 4

\*OBS.: NA VERSÃO DE 600mm A CAIXA DA CREMONA TEM UM DESLOCAMENTO PARA A PARTE INFERIOR DA VARETA.

**UDINESE**  
**ASSA ABLOY**

# CREMONA E25 EVO 2 PONTOS ACION. INTERNO

## APLICAÇÕES

**ABSOLUTA  
(CDA)**

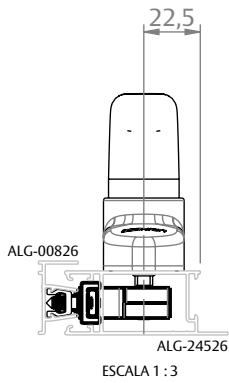

**ECOLINE 2,5  
(PERFIL ALUMÍNIO)**

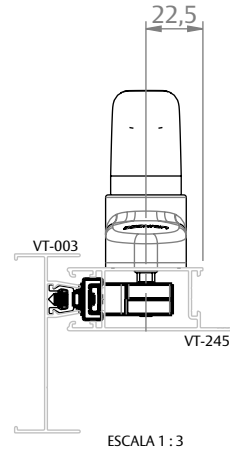

**SUPREMA  
(HYDRO)**

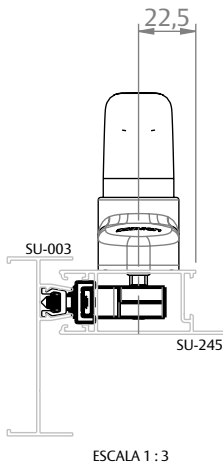

**AGLO 3.2  
(OLGA COLOR)**

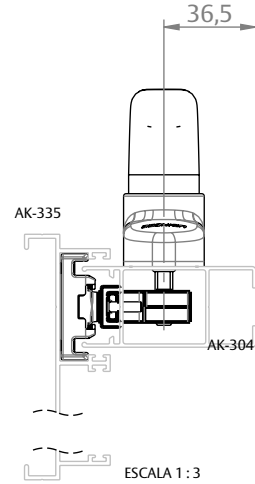

**CHROMA  
(PERFIL ALUMÍNIO)**

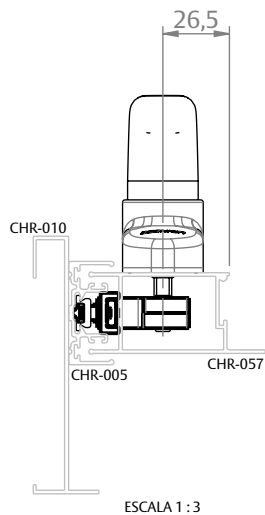

**D'ORO  
(CDA)**

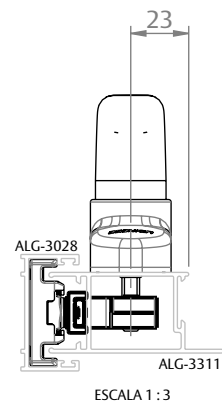

# CREMONA E25 EVO 2 PONTOS ACION. INTERNO

## APLICAÇÕES

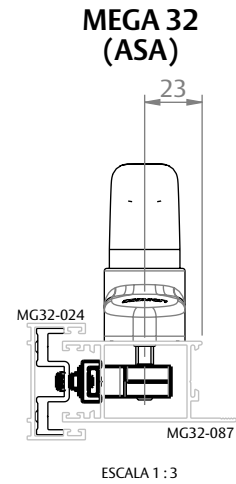
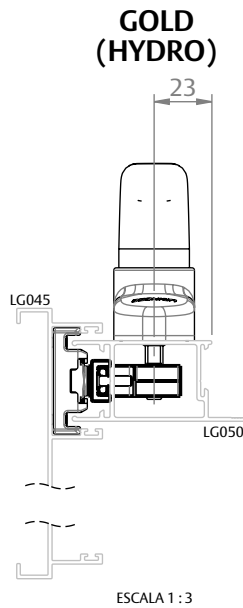

## TABELA GERAL (CONTRA FECHOS)

PRODUTO		LINHAS																	
		PERFIL ALUMÍNIO				HYDRO				CDA				OLGA COLOR		ASA ALUMÍNIO			
		ECOLINE 2.5		CHROMA		SUPREMA		GOLD		ABSOLUTA		D'ORO		RENOIR 3.3		AGLO 3.2		MEGA 32	
COMPONENTES		LAT	CENT	LAT	CENT	LAT	CENT	LAT	CENT	LAT	CENT	LAT	CENT	LAT	CENT	LAT	CENT	LAT	CENT
	CONTRA FECHO CREMONA (SUPREMA)	✓	✓			✓	✓			✓	✓								
	CONTRA FECHO CREMONA (CHR/ECO)			✓	✓														
	CONTRA FECHO REGULÁVEL GOLD (LATERAL)							✓				✓				✓			
	CONTRA FECHO REGULÁVEL GOLD (CENTRAL)								✓								✓		
	CONTRA FECHO CREMONA (LATERAL GDL)								✓			✓				✓		✓	
	CONTRA FECHO CREMONA (CENTRAL GDC)									✓			✓				✓		
	CONTRA FECHO REGULÁVEL CREMONA (RNR)																	✓	